

**Series**

**HEAT PUMP PEH-7, 8, 10**

	PEH-7	PEH-8	PEH-10
Cooling capacity (kW)	18.8	22.0	28.8
Heating capacity (kW)	19.4	22.0	28.8

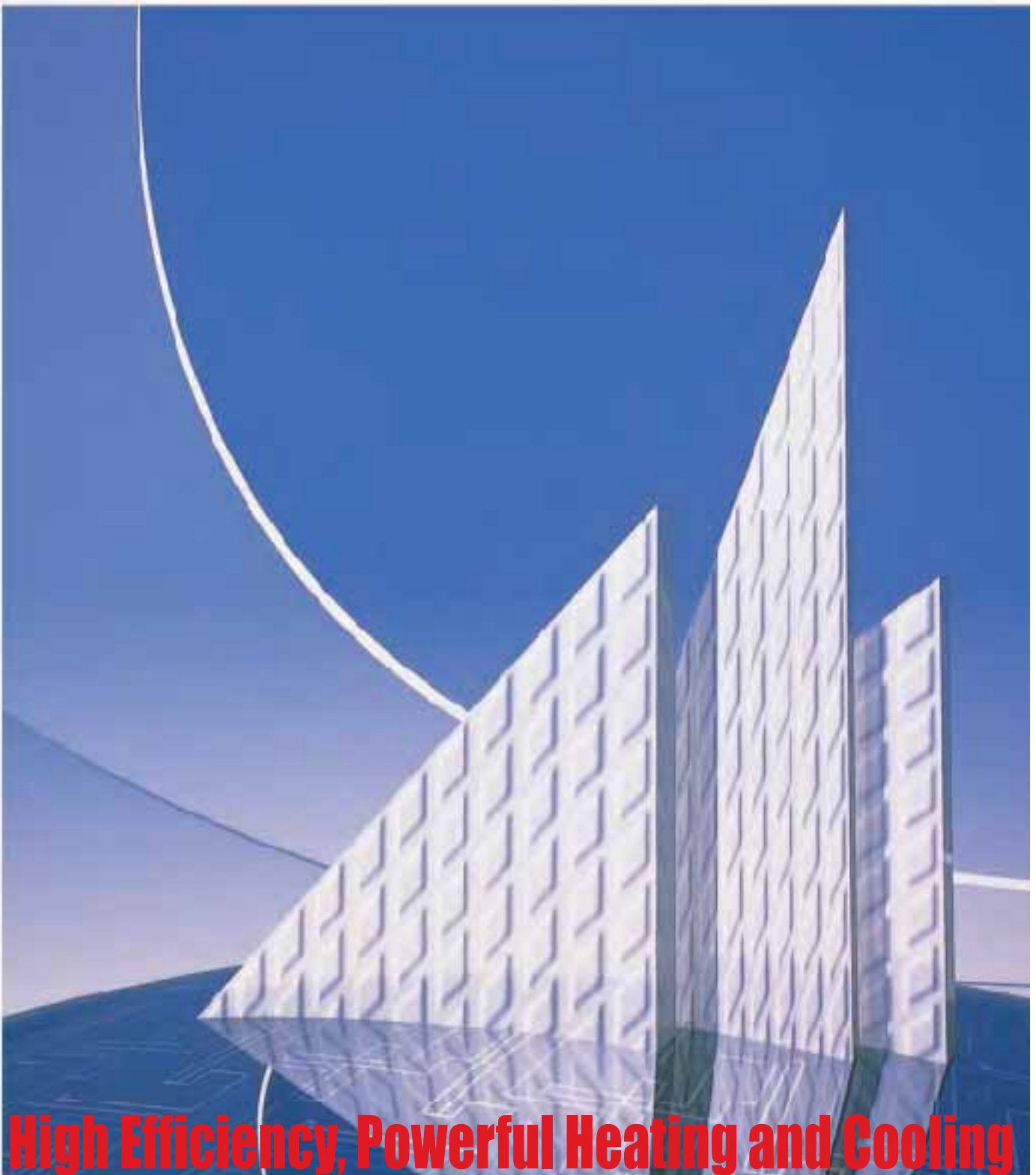

**High Efficiency, Powerful Heating and Cooling**

# 7/8/10HP Models Lined Up for Commercial & Residential Application

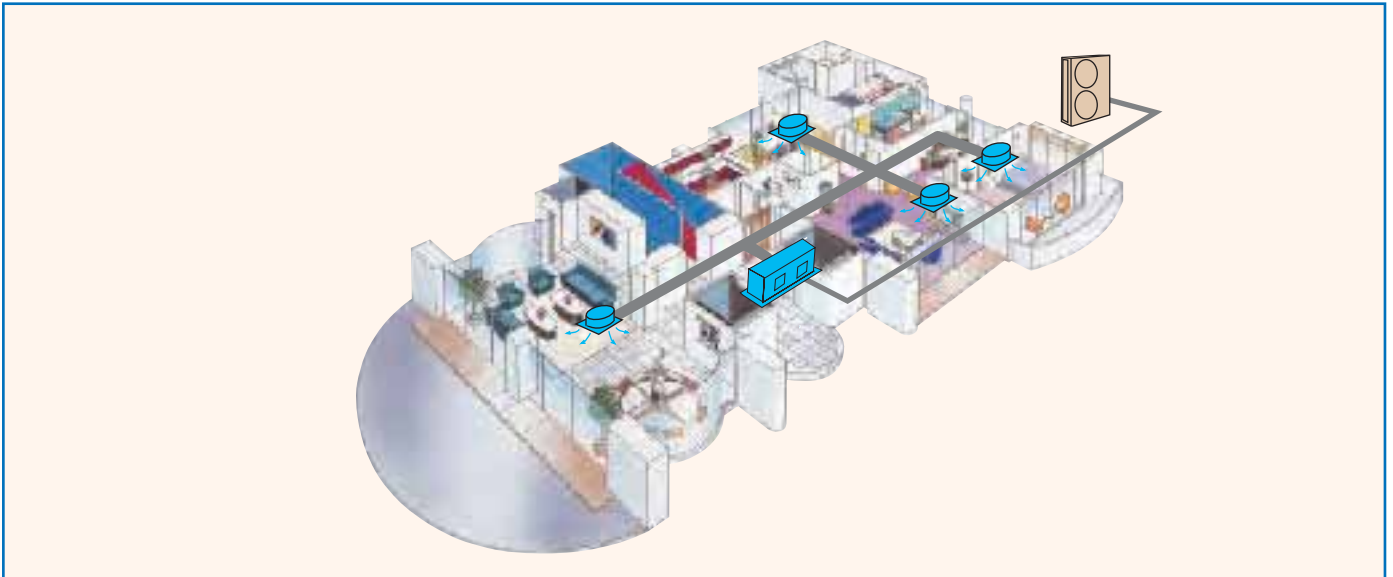

## Outdoor Unit

### New Model Outdoor Unit Dramatically Reduces the Installation Space

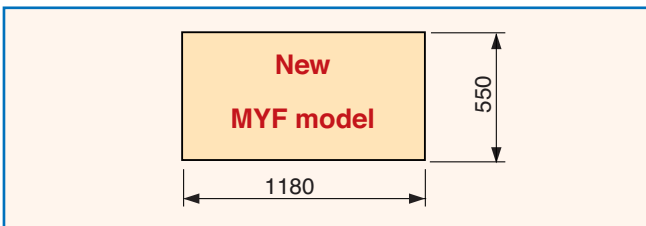

The installation space for each outdoor unit, including service space, has been reduced to 0.65m<sup>2</sup>.

### Quiet Operation

The low operating noise of the newly designed outdoor units (8/10HP) marks the industry leading level.

Noise level (dB)	New model (Cooling/Heating)	Previous model
PUH-7MYF	59/59	65
PUH-8MYF	59/59	65
PUH-10MYF	59/60	65

### Saltproof Fin Treatment of Outdoor Unit Meets Various Installations

### Wide Operation Range

Newly developed Fan Controller expands the operating ambient temperature.

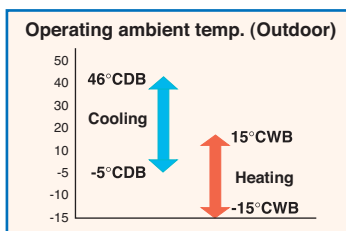

### Standard Finguard at Air Intake Side Enhances the Product Safety

## Indoor Unit

### Enabled to Change Fan Speed (7/8HP)

By introducing new 2-stage Fan Motor in the indoor unit, the fan speed can be changed (Hi/Lo) by the controller for extra comfort. (PEH-10 Fan speed is preset at high speed.)

### Affordable External Static Pressure

To provide flexibility for duct extension, branching and outlet configuration.

	7	8	10
External static pressure (Pa)	125	125	150

### Automatic Cooling/Heating Changeover Operation for More Comfort

### Extra Quiet Operation

Along with the innovative noise suppression features found on other Mitsubishi Electric air conditioners, the PEH Series incorporates an improved sirrocco fan to reduce noise.

	7	8	10
Noise level (dB : at Lo-notch)	55	56	59

### Limitations on Piping Length

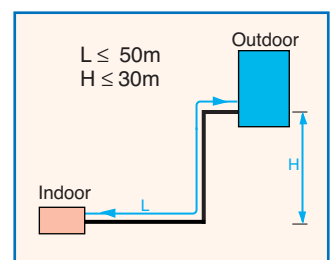
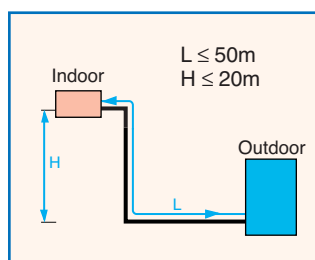

# Enhanced System Control and Operation Ease

## Wiring Needs Halved—Remarkable Saving in Cost and Labor

Interactive system management, incorporated using an original technology we call "A-Control," is provided by a single 3-wire power/control cable connecting system components. In addition, a non-polarized, dual core wire employed for the remote control line further facilitates installation work.

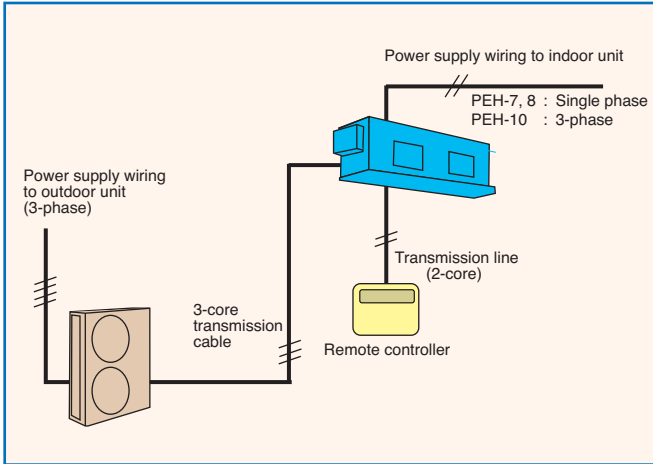

## Full System Diagnosis

"A-Control" interactivity between indoor and outdoor units enables the system's self-diagnostic function to be used for examining the entire system; even abnormalities in the outdoor unit will be shown on the remote controller display. Improvements in display details make more accurate and timely responses for maintenance and repair possible.

### Remote display alternately shows error code and corresponding model number

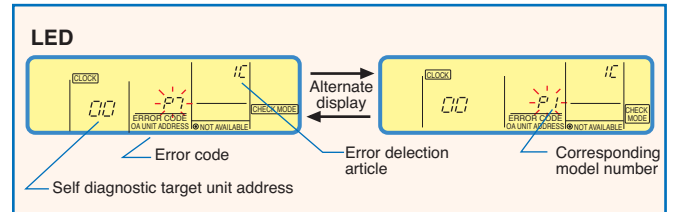

## Building Management System Compatibility

"A-Control" technology offers compatibility so that systems of the series can operate as part of the MELANS building air conditioning management system. Once connected by a special adapter (optional), the systems respond to commands given from the MELANS control center. The remote controller can also be used for general system control.

### M-NET (MELANS) connection

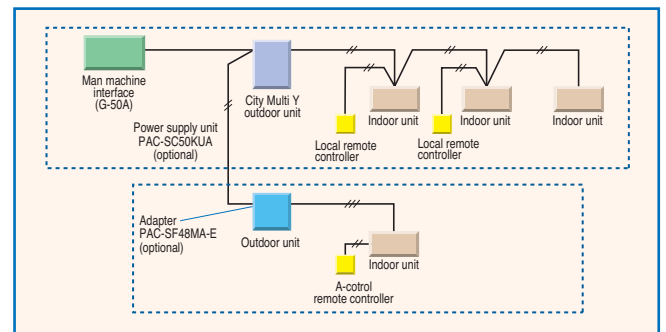

## Flexible Function Setting from Remote Controllers Prepared as Standard

Remote Controllers can now be used for the selection and setting of functions such as fan speed, air outlets, etc. which were previously set from the indoor unit base board. Setting changes can also be made very easily at the installation stage.

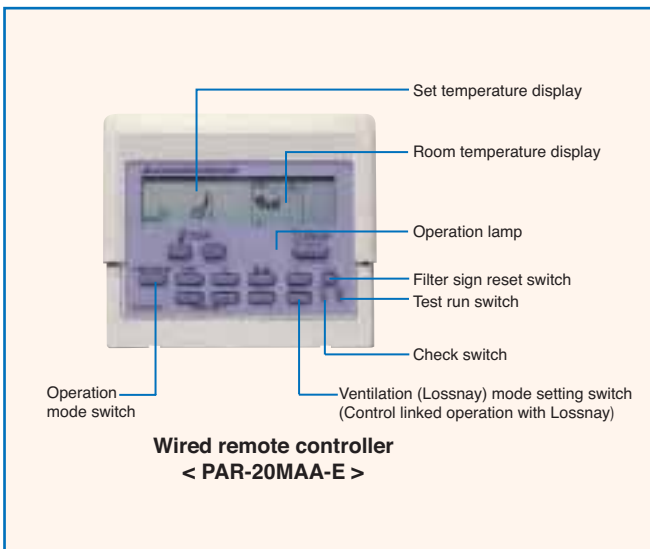

## Efficient Lossnay Ventilation Management

The Lossnay ventilation system can be easily connected to and controlled by the interactive "A-Control" system using an adapter. The combined interlocking system offers the ability to remove unclean air from indoor environments while adding 25% savings in operating costs for ventilation compared to conventional systems. Independent control of the Lossnay is also possible.

### Lossnay operation managed by "A-Control"

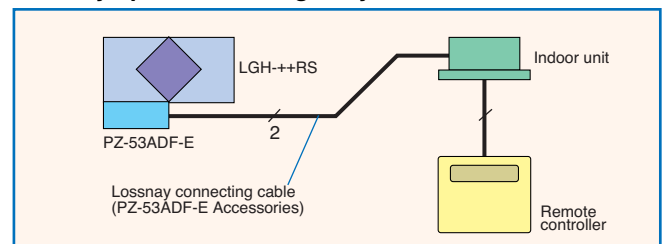

## Use of Two Remote Controllers per Group

Thanks to the employment of "A-Control", the remote controller can be installed up to two sets per system. This greatly upgrades operability in residential and commercial application.

# Specifications

Model name			PEH-7MYB	PEH-8MYB	PEH-10MYB
Service reference			PEH-7MYB-EU	PEH-8MYB-EU	PEH-10MYB-EU
Power supply	Indoor		~ 220~240V 50Hz		3N~ 380~415V 50Hz
	Outdoor		3N~ 380~415V 50Hz		
Total cooling capacity (Gross)	kW		18.8	22.0	28.8
	BTU/h		64,200	75,100	98,300
	kcal/h		16,200	19,000	24,800
Sensible cooling capacity (Gross)	kW		16.2	18.7	24.8
	BTU/h		55,300	63,800	84,600
	kcal/h		14,000	16,100	21,400
Total cooling capacity (Net)	kW		18.1	21.1	27.7
	BTU/h		61,800	72,000	94,500
	kcal/h		15,600	18,200	23,900
Total heating capacity (Net)	kW		20.1	22.0	28.8
	BTU/h		68,600	75,100	93,800
	kcal/h		17,300	19,000	24,800
Capacity step	%		0 – 100		
Refrigerant			R-22		
Refrigerant charge	kg		5.7	6.6	9.9
Refrigerant control			Capillary tube		
Indoor unit	Model name		PEH-7MYB	PEH-8MYB	PEH-10MYB
	Service reference		PEH-7MYB-EU	PEH-8MYB-EU	PEH-10MYB-EU
External finish			Galvanized steel		
Dimension	Height	mm	428		
	Width	mm	1,380		1,580
	Depth	mm	650		
Net weight	kg		67	70	84
Indoor coil			Cross fin coil		
Indoor fan			Centrifugal (plastic) – Direct drive		
Indoor fan motor			1-phase induction motor		3-phase induction motor
No. x Motor output	kW		1 x 0.21	1 x 0.4	1 x 1.0
Indoor fan airflow (Lo-Hi)	CMM		48/60	56/70	90
	CFM		1,695/2,119	1,978/2,472	3,179
	L/S		800/1,000	933/1,167	1,500
External static pressure	mmAq		12.5		15
	Pa		125		150
Sound pressure level	dB(A)		55	56	59
Drain connection	mm		25.4		
Outdoor unit	Model name		PUH-7MYF	PUH-8MYF	PUH-10MYF
	Service reference		PUH-7MYF-EUS	PUH-8MYF-EUS	PUH-10MYF-EUS
External finish			Acrylic resin coating		
Color			MUNSELL 5Y 8/1		
Dimension	Height	mm	1,480		
	Width	mm	1,180		
	Depth	mm	550 (642)		
Net weight	kg		188 (193) *5		221 (226) *5
Compressor			Hermetic line start		
No. x Motor output	kW		1 x 5.0	1 x 5.5	1 x 7.5
Outdoor coil			Cross fin coil (Saltproof treatment)		
Outdoor fan			Propeller-direct drive		
Outdoor fan motor			3-phase induction motor		
No. x Motor output	kW		2 x 0.09		2 x 0.15
Outdoor fan airflow	CMM		167		190
	CFM		5,898		6,711
	L/S		2,783		3,167
Sound pressure level (Cooling/Heating)	dB(A)		59/59		59/60
Protection devices			High pressure switch, Freeze & frost protection fuse, Overcurrent relay (compressor& indoor fan), Internal thermostat (compressor, indoor fan & outdoor fan)		

## Note :

- Cooling and heating capacities are based on the following conditions:  
Cooling : Indoor: 27°CDB, 19°CWB, Outdoor: 35°CDB  
Heating : Indoor: 20°CDB, Outdoor: 7°CDB, 6°CWB  
Cooling and heating capacities are based on 5m pipe length.
- Refrigerant charge volumes are factory charged (at 5m piping length).  
Refrigerant is enclosed in the outdoor unit.
- The measuring point of the sound pressure level is 1m from the unit surface.
- Specifications subject to change without notice.
- Figure in ( ) indicates the dimension with built-in air outlet guide.

# Outline Dimensions

(Unit : mm)

## Model PEH-7, 8MYB

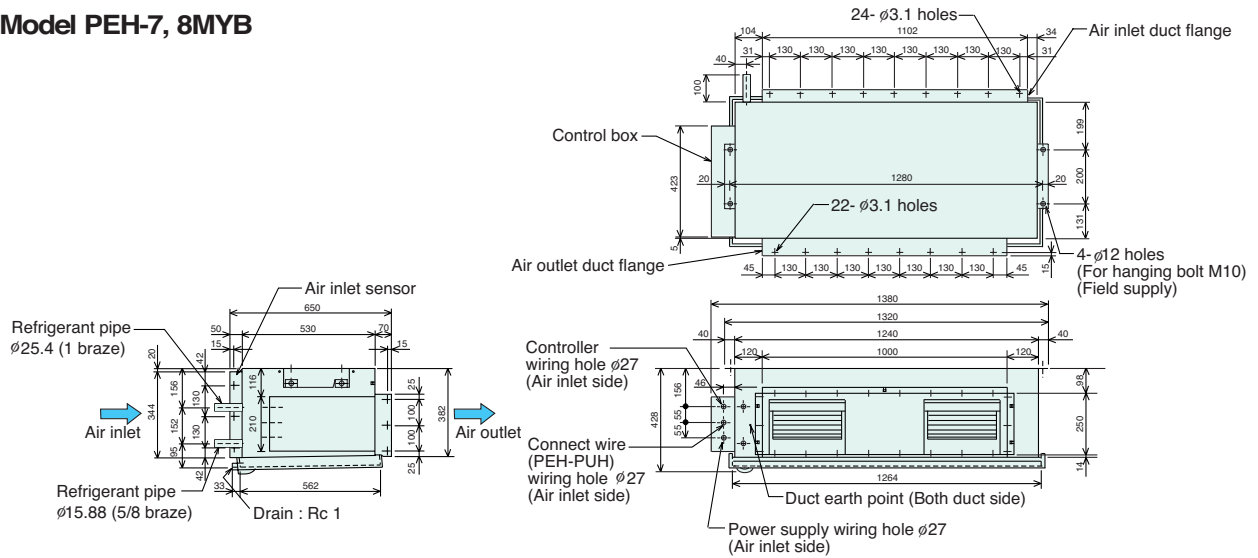

## Model PEH-10MYB

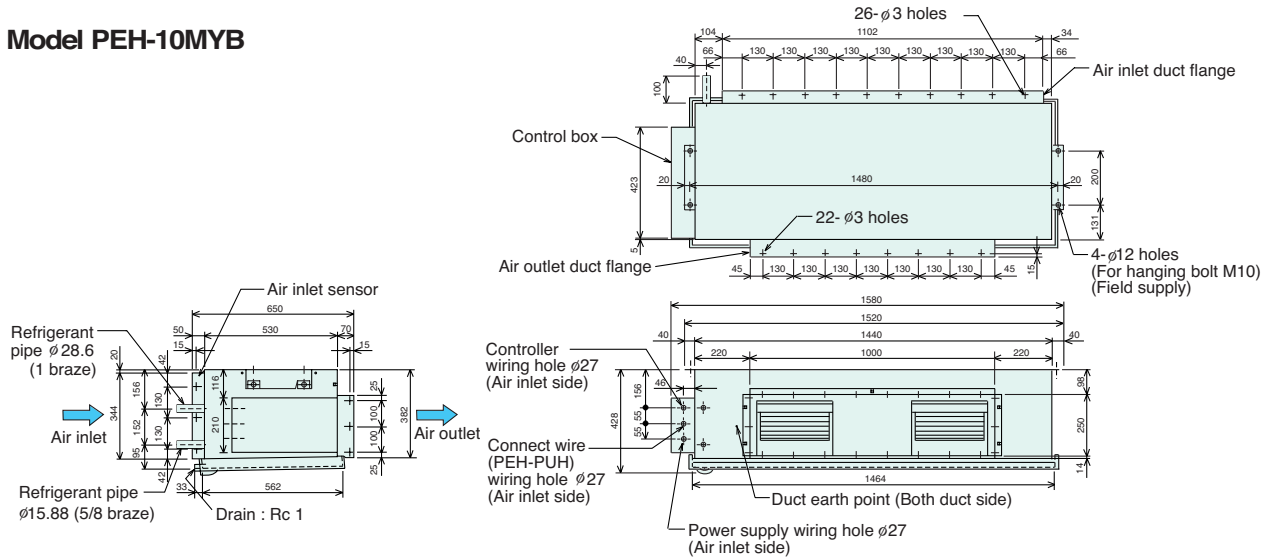

## Model PUH-7, 8, 10MYF

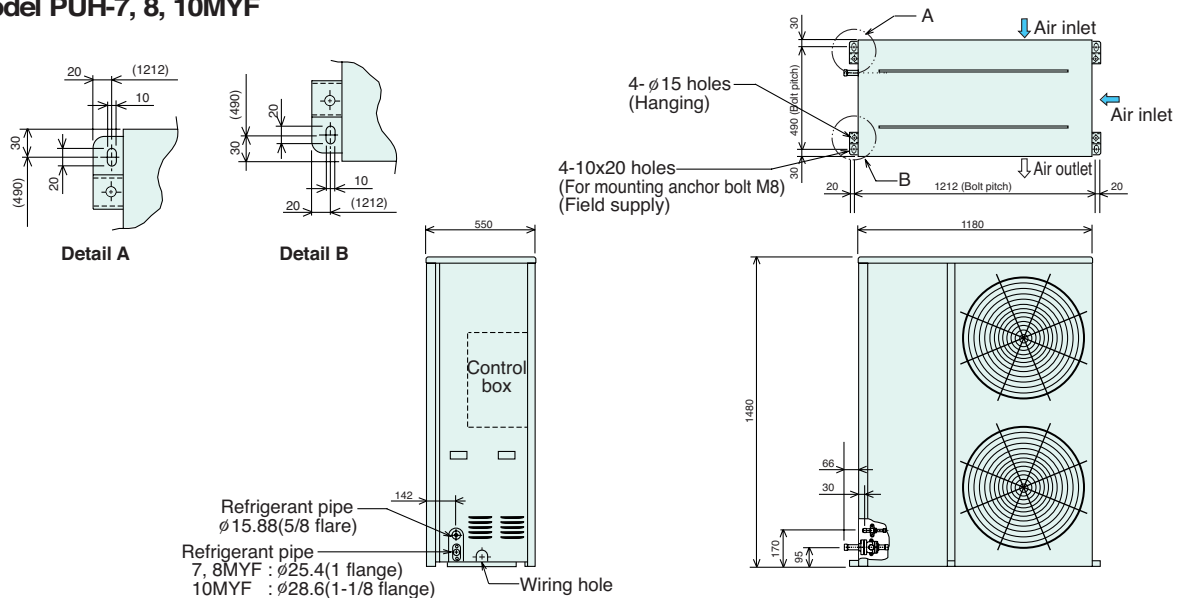

# Outline Dimensions

Model PUH-7, 8, 10MYF (with optional air outlet guide)

(Unit : mm)

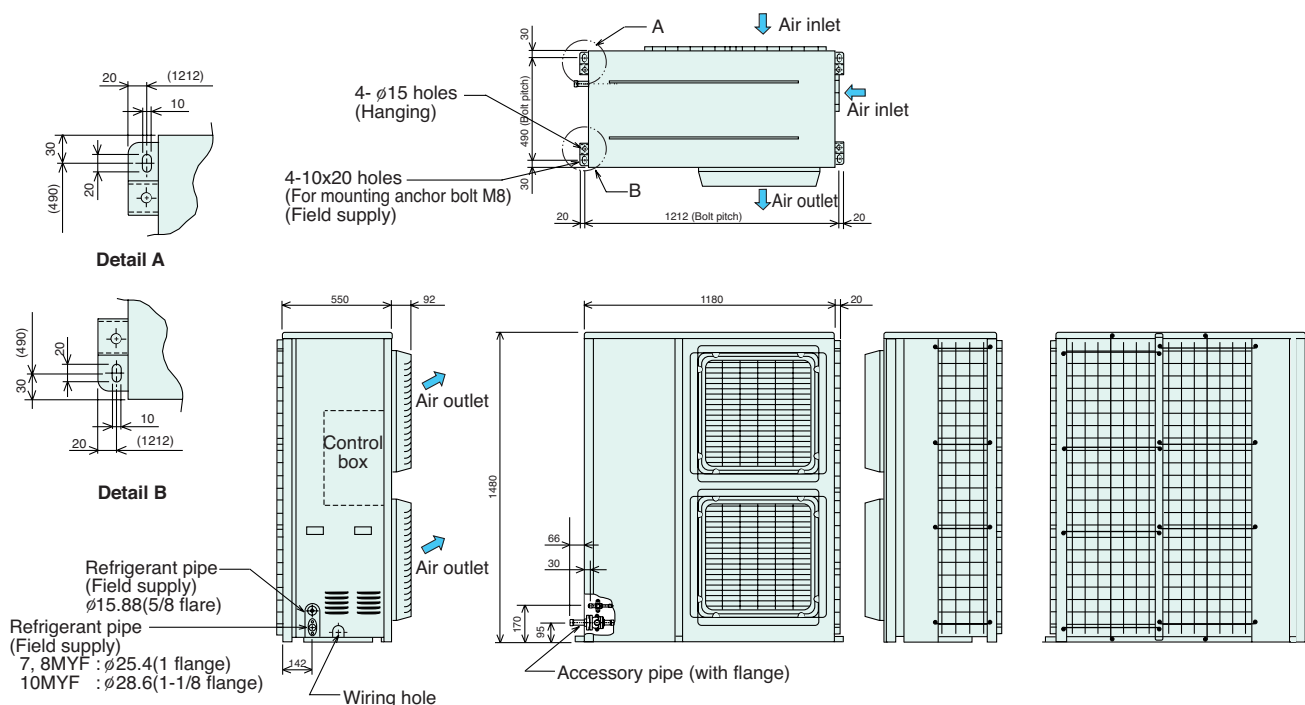

## Main Optional Parts

Model	Description
PAR-20MAA-E	Standard remote controller
PAC-SF48MA	M-A transmission converter
PAC-YT32PTA	Program timer
PAC-SE41TS-E	Remote sensor
PAC-SF40RM-E	Remote operation adapter
PAC-SE55RA-E	Remote ON/OFF adapter

## Guaranteed Operation Range

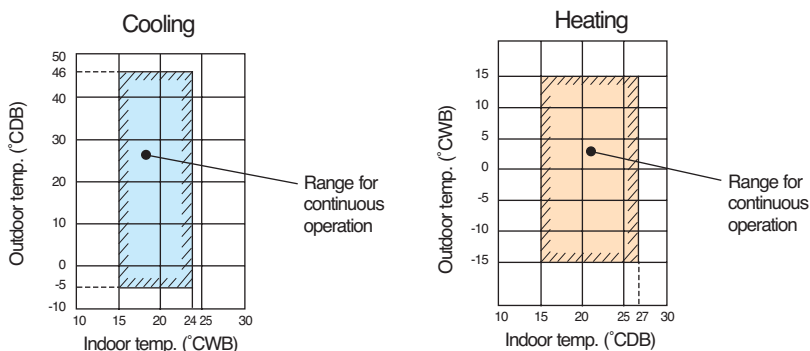

Note:  
 As an applicable humidity outside standard for both indoors and outdoors, we recommend use within a range of 35-80% relative humidity. However, it is a condition that there is no be dewy in surfaces of electric parts.

**MITSUBISHI ELECTRIC CORPORATION**  
 HEAD OFFICE: MITSUBISHI DENKI BLDG., 2-2-3, MARUNOUCHI, CHIYODA-KU, TOKYO 100-8310, JAPAN